

## Product Summary

$V_{(BR)DSS}$	$R_{DS(on)}$	$I_D$ max $T_A = 25^\circ\text{C}$ (Note 5)
30V	12.5m $\Omega$ @ $V_{GS} = 10\text{V}$	11.7A
	14.8m $\Omega$ @ $V_{GS} = 4.5\text{V}$	10.8A

## Description and Applications

This new generation MOSFET has been designed to minimize the on-state resistance ( $R_{DS(on)}$ ) and yet maintain superior switching performance, making it ideal for high efficiency power management applications.

- DC-DC Converters
- Power management functions



Top View

## Features

- DIOFET utilizes a unique patented process to monolithically integrate a MOSFET and a Schottky in a single die to deliver:
  - Low  $R_{DS(ON)}$  - minimizes conduction losses
  - Low  $V_{SD}$  - reducing the losses due to body diode conduction
  - Low  $Q_{rr}$  - lower  $Q_{rr}$  of the integrated Schottky reduces body diode switching losses
  - Low gate capacitance ( $Q_g/Q_{gs}$ ) ratio – reduces risk of shoot-through or cross conduction currents at high frequencies
  - Avalanche rugged –  $I_{AR}$  and  $E_{AR}$  rated
- **Lead Free, RoHS Compliant (Note 1)**
- **"Green" Device (Note 2)**
- **Qualified to AEC-Q101 Standards for High Reliability**

## Mechanical Data

- Case: SO-8
- Case Material: Molded Plastic, "Green" Molding Compound. UL Flammability Classification Rating 94V-0
- Moisture Sensitivity: Level 1 per J-STD-020
- Terminal Connections: See Diagram Below
- Weight: 0.072 grams (approximate)

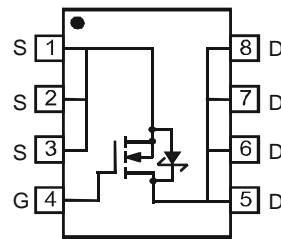

Top View  
Internal Schematic

## Ordering Information (Note 3)

Part Number	Case	Packaging
DMG4710SSS-13	SO-8	2500 / Tape & Reel

- Notes:
1. No purposefully added lead.
  2. Diodes Inc.'s "Green" policy can be found on our website at <http://www.diodes.com>.
  3. For packaging details, go to our website at <http://www.diodes.com>.

## Marking Information

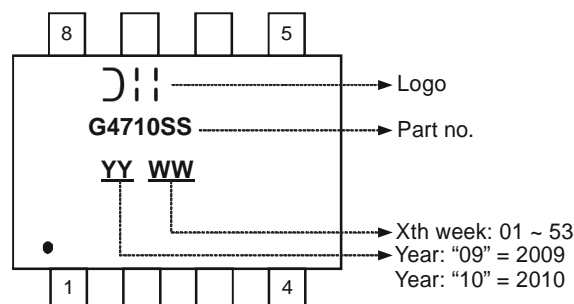

**Maximum Ratings** @T<sub>A</sub> = 25°C unless otherwise specified

Characteristic			Symbol	Value	Unit
Drain-Source Voltage			V <sub>DSS</sub>	30	V
Gate-Source Voltage			V <sub>GSS</sub>	±12	V
Continuous Drain Current (Note 4) V <sub>GS</sub> = 10V	Steady State	T <sub>A</sub> = 25°C T <sub>A</sub> = 85°C	I <sub>D</sub>	8.8 6.3	A
Continuous Drain Current (Note 5) V <sub>GS</sub> = 10V	t ≤ 10 sec	T <sub>A</sub> = 25°C T <sub>A</sub> = 85°C	I <sub>D</sub>	11.7 8.5	A
Continuous Drain Current (Note 5) V <sub>GS</sub> = 4.5V	t ≤ 10 sec	T <sub>A</sub> = 25°C T <sub>A</sub> = 85°C	I <sub>D</sub>	10.8 7.8	A
Pulsed Drain Current (Note 6)			I <sub>DM</sub>	90	A
Avalanche Current (Notes 6 & 7)			I <sub>AR</sub>	13	A
Repetitive Avalanche Energy (Notes 6 & 7) L = 0.3mH			E <sub>AR</sub>	25.4	mJ

**Thermal Characteristics**

Characteristic	Symbol	Value	Unit
Power Dissipation (Note 4)	P <sub>D</sub>	1.54	W
Thermal Resistance, Junction to Ambient @T <sub>A</sub> = 25°C (Note 4)	R <sub>θJA</sub>	81	°C/W
Power Dissipation (Note 5)	P <sub>D</sub>	2.8	W
Thermal Resistance, Junction to Ambient @T <sub>A</sub> = 25°C (Note 5)	R <sub>θJA</sub>	45	°C/W
Operating and Storage Temperature Range	T <sub>J</sub> , T <sub>STG</sub>	-55 to +150	°C

**Electrical Characteristics** @ T<sub>A</sub> = 25°C unless otherwise stated

Characteristic	Symbol	Min	Typ	Max	Unit	Test Condition
<b>OFF CHARACTERISTICS (Note 8)</b>						
Drain-Source Breakdown Voltage	BV <sub>DSS</sub>	30	-	-	V	V <sub>GS</sub> = 0V, I <sub>D</sub> = 1mA
Zero Gate Voltage Drain Current	I <sub>DSS</sub>	-	-	0.1	mA	V <sub>DS</sub> = 30V, V <sub>GS</sub> = 0V
Gate-Source Leakage	I <sub>GSS</sub>	-	-	±100	nA	V <sub>GS</sub> = ±12V, V <sub>DS</sub> = 0V
<b>ON CHARACTERISTICS (Note 8)</b>						
Gate Threshold Voltage	V <sub>GS(th)</sub>	1.0	-	2.3	V	V <sub>DS</sub> = V <sub>GS</sub> , I <sub>D</sub> = 250μA
Static Drain-Source On-Resistance	R <sub>DS(on)</sub>	-	9.5	12.5	mΩ	V <sub>GS</sub> = 10V, I <sub>D</sub> = 11.7A
		-	11.5	14.8		V <sub>GS</sub> = 4.5V, I <sub>D</sub> = 10.8A
Forward Transfer Admittance	Y <sub>fs</sub>	-	22	-	S	V <sub>DS</sub> = 5V, I <sub>D</sub> = 11.7A
Diode Forward Voltage	V <sub>SD</sub>	-	0.38	0.6	V	V <sub>GS</sub> = 0V, I <sub>S</sub> = 1A
Maximum Body-Diode + Schottky Continuous Current	I <sub>S</sub>	-	-	5	A	-
<b>DYNAMIC CHARACTERISTICS (Note 9)</b>						
Input Capacitance	C <sub>iss</sub>	-	1849	-	pF	V <sub>DS</sub> = 15V, V <sub>GS</sub> = 0V, f = 1.0MHz
Output Capacitance	C <sub>oss</sub>	-	158	-	pF	
Reverse Transfer Capacitance	C <sub>rss</sub>	-	123	-	pF	
Gate Resistance	R <sub>g</sub>	0.54	2.68	4.82	Ω	V <sub>DS</sub> = 0V, V <sub>GS</sub> = 0V, f = 1MHz
Total Gate Charge V <sub>GS</sub> = 4.5V	Q <sub>g</sub>	-	18.5	-	nC	V <sub>DS</sub> = 15V, V <sub>GS</sub> = 10V, I <sub>D</sub> = 11.7A
Total Gate Charge V <sub>GS</sub> = 10V	Q <sub>g</sub>	-	43	-	nC	
Gate-Source Charge	Q <sub>gs</sub>	-	4.7	-	nC	
Gate-Drain Charge	Q <sub>gd</sub>	-	4.0	-	nC	
Turn-On Delay Time	t <sub>D(on)</sub>	-	6.62	-	ns	
Turn-On Rise Time	t <sub>r</sub>	-	8.73	-	ns	V <sub>GS</sub> = 10V, V <sub>DS</sub> = 10V, R <sub>G</sub> = 3Ω, R <sub>L</sub> = 1.2Ω
Turn-Off Delay Time	t <sub>D(off)</sub>	-	36.41	-	ns	
Turn-Off Fall Time	t <sub>f</sub>	-	4.69	-	ns	

- Notes:
- Device mounted on FR-4 PCB with minimum recommended pad layout. The value in any given application depends on the user's specific board design.
  - Device mounted on 1" x 1" FR-4 PCB with high coverage 1 oz. Copper, single sided, device is measured at t ≤ 10 sec.
  - Repetitive rating, pulse width limited by junction temperature.
  - I<sub>AR</sub> and E<sub>AR</sub> rating are based on low frequency and duty cycles to keep T<sub>J</sub> = 25°C
  - Short duration pulse test used to minimize self-heating effect.
  - Guaranteed by design. Not subject to production testing.

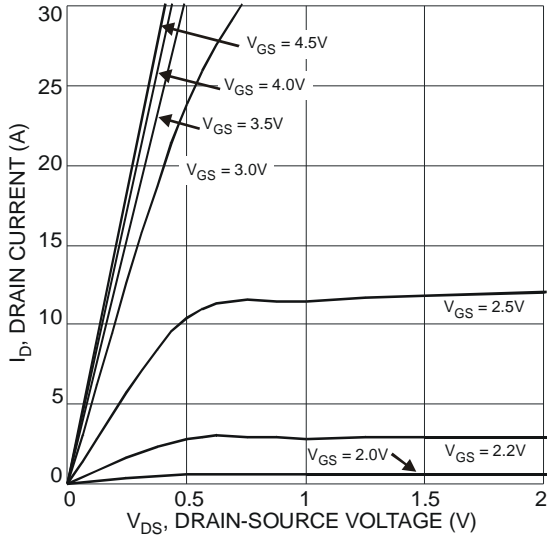

Fig. 1 Typical Output Characteristic

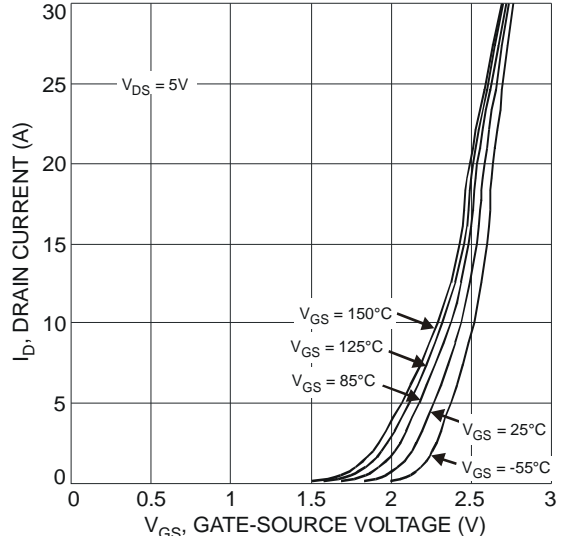

Fig. 2 Typical Transfer Characteristic

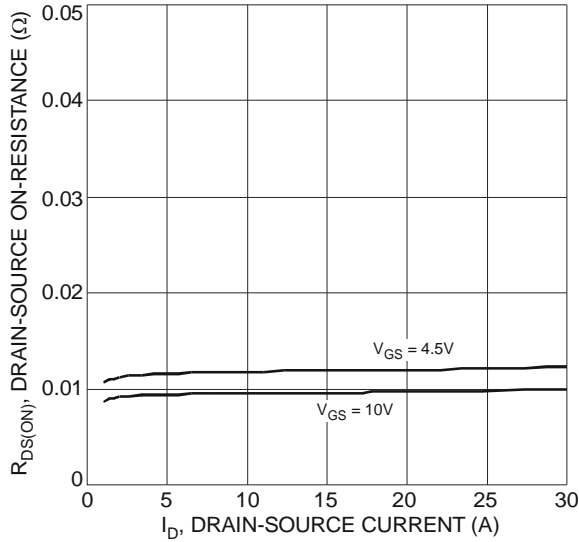

Fig. 3 Typical On-Resistance vs. Drain Current and Gate Voltage

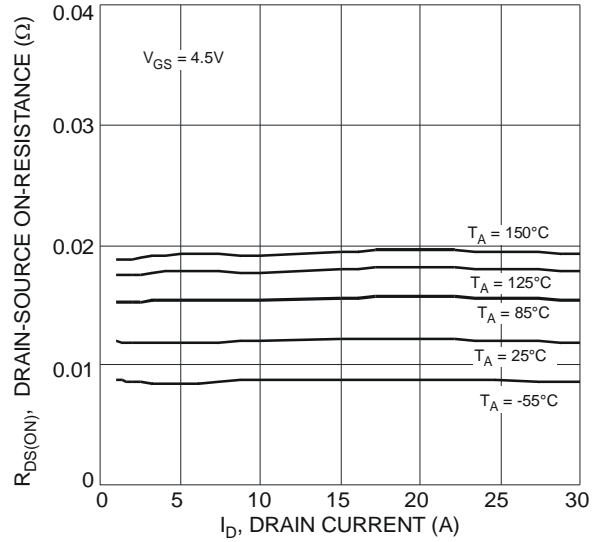

Fig. 4 Typical On-Resistance vs. Drain Current and Temperature

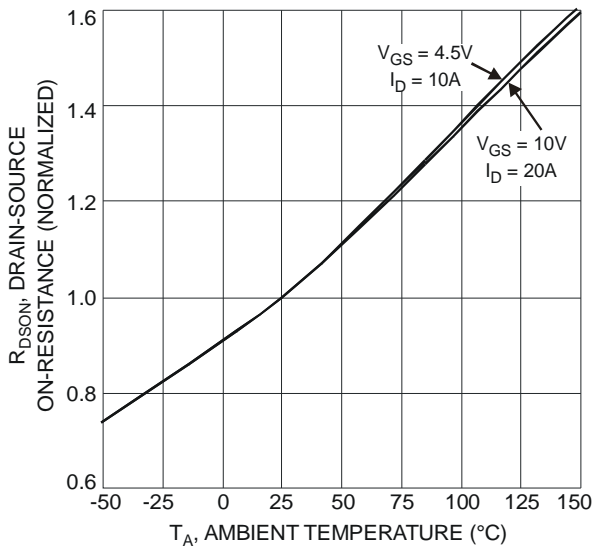

Fig. 5 On-Resistance Variation with Temperature

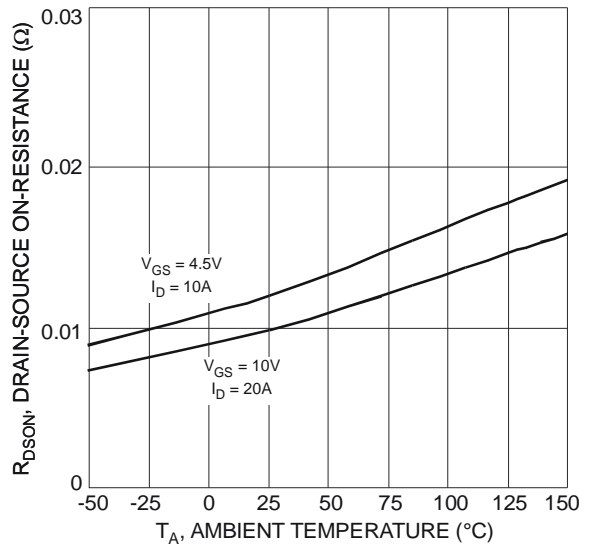

Fig. 6 On-Resistance Variation with Temperature

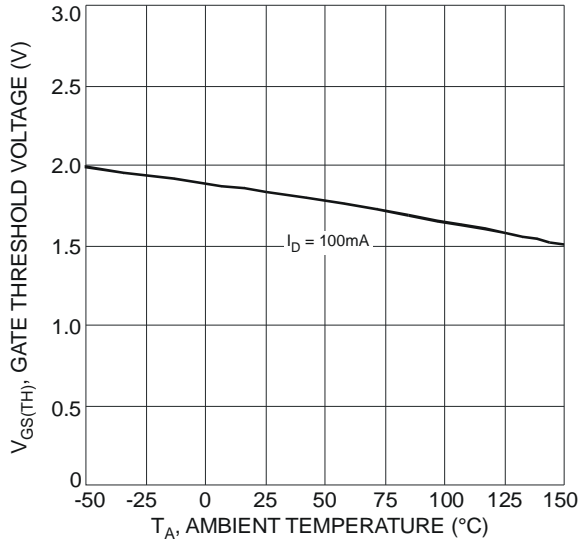

Fig. 7 Gate Threshold Variation vs. Ambient Temperature

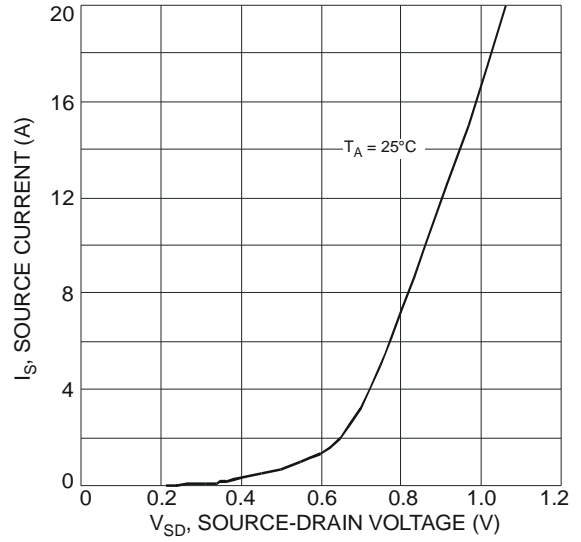

Fig. 8 Diode Forward Voltage vs. Current

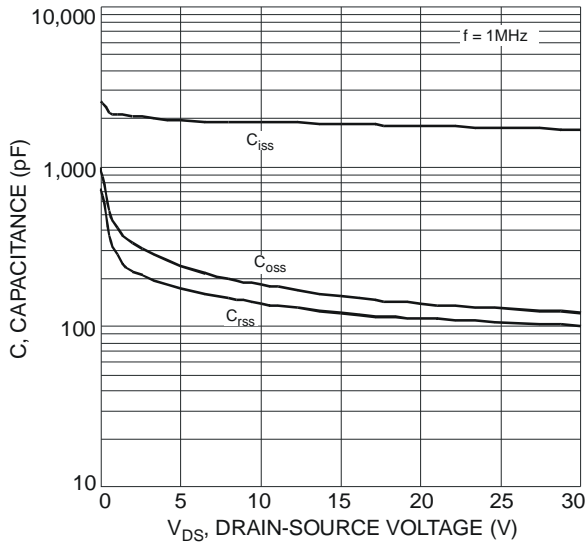

Fig. 9 Typical Total Capacitance

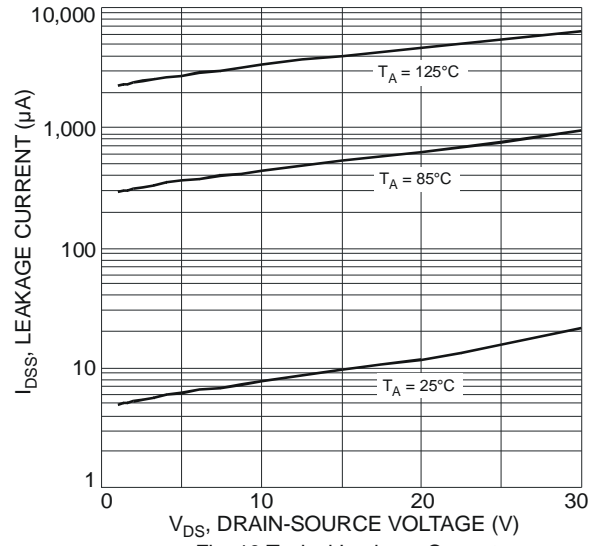

Fig. 10 Typical Leakage Current vs. Drain-Source Voltage

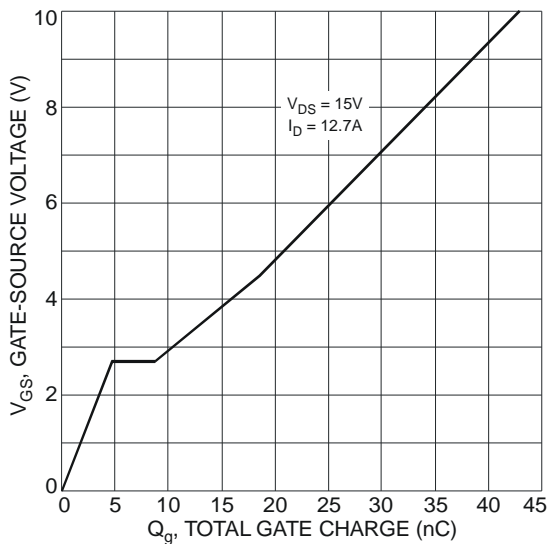

Fig. 11 Gate-Charge Characteristics

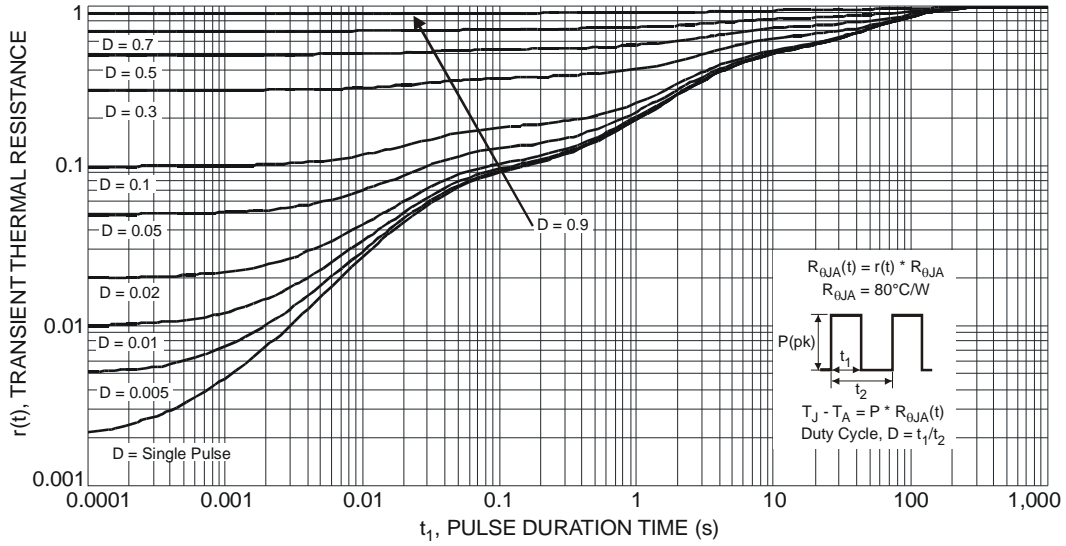
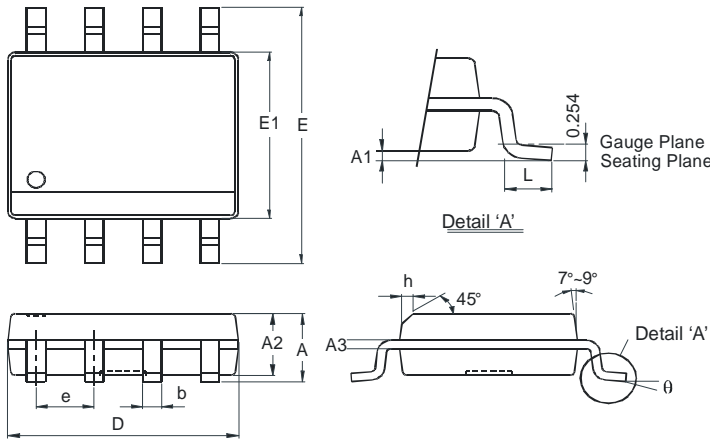

Fig. 12 Transient Thermal Response

**Package Outline Dimensions**



SO-8		
Dim	Min	Max
A	-	1.75
A1	0.10	0.20
A2	1.30	1.50
A3	0.15	0.25
b	0.3	0.5
D	4.85	4.95
E	5.90	6.10
E1	3.85	3.95
e	1.27 Typ	
h	-	0.35
L	0.62	0.82
θ	0°	8°
All Dimensions in mm		

**Suggested Pad Layout**

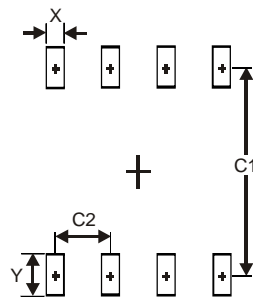

Dimensions	Value (in mm)
X	0.60
Y	1.55
C1	5.4
C2	1.27

**IMPORTANT NOTICE**

DIODES INCORPORATED MAKES NO WARRANTY OF ANY KIND, EXPRESS OR IMPLIED, WITH REGARDS TO THIS DOCUMENT, INCLUDING, BUT NOT LIMITED TO, THE IMPLIED WARRANTIES OF MERCHANTABILITY AND FITNESS FOR A PARTICULAR PURPOSE (AND THEIR EQUIVALENTS UNDER THE LAWS OF ANY JURISDICTION).

Diodes Incorporated and its subsidiaries reserve the right to make modifications, enhancements, improvements, corrections or other changes without further notice to this document and any product described herein. Diodes Incorporated does not assume any liability arising out of the application or use of this document or any product described herein; neither does Diodes Incorporated convey any license under its patent or trademark rights, nor the rights of others. Any Customer or user of this document or products described herein in such applications shall assume all risks of such use and will agree to hold Diodes Incorporated and all the companies whose products are represented on Diodes Incorporated website, harmless against all damages.

Diodes Incorporated does not warrant or accept any liability whatsoever in respect of any products purchased through unauthorized sales channel. Should Customers purchase or use Diodes Incorporated products for any unintended or unauthorized application, Customers shall indemnify and hold Diodes Incorporated and its representatives harmless against all claims, damages, expenses, and attorney fees arising out of, directly or indirectly, any claim of personal injury or death associated with such unintended or unauthorized application.

Products described herein may be covered by one or more United States, international or foreign patents pending. Product names and markings noted herein may also be covered by one or more United States, international or foreign trademarks.

**LIFE SUPPORT**

Diodes Incorporated products are specifically not authorized for use as critical components in life support devices or systems without the express written approval of the Chief Executive Officer of Diodes Incorporated. As used herein:

- A. Life support devices or systems are devices or systems which:
  - 1. are intended to implant into the body, or
  - 2. support or sustain life and whose failure to perform when properly used in accordance with instructions for use provided in the labeling can be reasonably expected to result in significant injury to the user.
- B. A critical component is any component in a life support device or system whose failure to perform can be reasonably expected to cause the failure of the life support device or to affect its safety or effectiveness.

Customers represent that they have all necessary expertise in the safety and regulatory ramifications of their life support devices or systems, and acknowledge and agree that they are solely responsible for all legal, regulatory and safety-related requirements concerning their products and any use of Diodes Incorporated products in such safety-critical, life support devices or systems, notwithstanding any devices- or systems-related information or support that may be provided by Diodes Incorporated. Further, Customers must fully indemnify Diodes Incorporated and its representatives against any damages arising out of the use of Diodes Incorporated products in such safety-critical, life support devices or systems.

Copyright © 2010, Diodes Incorporated

**www.diodes.com**